

GREEN HERON ENGINEERING & K7NV Prop Pitch Systems



RT-21_{PP} DIGITAL ROTATOR CONTROLLER FOR K7NV PROP PITCH ROTATORS USER GUIDE

Document Revision 1.0
S/N 700 + (PCB Rev 1.8, 1.9)
includes features through Software Revision 1.7
January 11, 2011

© 2011 Green Heron Engineering LLC

1107 Salt Road, Webster, NY 14580
Phone 585.217.9093
www.GreenHeronEngineering.com

RADIO AND TELEVISION INTERFERENCE

This equipment has been tested and found to comply with the limits for a Class B digital device, pursuant to Part 15 of the FCC rules. These limits are designed to provide reasonable protection against harmful interference in a residential installation. This equipment generates, uses and can radiate radio frequency energy and, if not installed and used in accordance with the instructions, may cause harmful interference to radio communications. However, there is no guarantee that interference will not occur in a particular installation. If this equipment does cause harmful interference to radio or television reception, which can be determined by turning the equipment off and on, the user is encouraged to try to correct the interference by one or more of the following measures:

- Reorient or relocate the receiving antenna.
- Increase the separation between the equipment and the receiver.
- Connect the equipment into an outlet on a circuit different from that to which the receiver is connected.
- Consult the dealer or an experienced radio/TV technician for help.

You may also find helpful the following booklet, prepared by the FCC: "How to Identify and Resolve Radio-TV Interference Problems." This booklet is available from the U.S. Government Printing Office, Washington D.C. 20402.

Changes and Modifications not expressly approved by the manufacturer or registrant of this equipment can void your authority to operate this equipment under Federal Communications Commissions rules.

NOTICE

Green Heron Engineering reserves the right to make changes for product improvement or manufacturing, without notice or any obligation to update units already sold.

WARRANTY

This product is warranted to be free of defects in materials and workmanship for 1 year. We will repair or replace, at our option, any equipment proven to be defective within the warranty period. All warranty work is F.O.B. Webster, NY, USA. This warranty is exclusive of abuse, misuse, accidental damage, acts of God or consequential damages, etc. Green Heron Engineering LLC liability shall not exceed the original purchase price of the equipment.



This unit is normally supplied with a 3.5 Amp Slo-Blo 5x20 mm fuse in the rear panel fuse holder.

If it is necessary, replace only with:

115 VAC – 4 amp SB max

230 VAC – 2 amp SB max

Table of Contents

1.0	QUICK START GUIDE	1
1.1	JUMPERS AND SETTINGS	3
1.2	VERIFY 115/230 VAC SWITCH	3
1.3	SET THE OFFSET VALUE (DEFAULT IS NORTH CENTER, OFFSET = 180)	3
1.4	SET THE COUNTER DIVIDE RATIO (DEFAULT = 9576 - FOR SMALL PP UNITS)	4
1.5	CONNECT THE RT-21PP TO YOUR ROTATOR	5
1.6	CALIBRATE YOUR ROTATOR	5
1.7	SPEED AND RAMP ADJUSTMENTS	6
2.0	FRONT PANEL CONTROLS & DISPLAY	7
2.1	FRONT PANEL CONTROLS	7
2.2	FRONT PANEL DISPLAY	10
3.0	SETUP MODE	11
3.1	OPTION PARAMETER	11
3.2	SETTING OTHER PARAMETERS	12
4.0	OPERATING HINTS & ADVANCED FEATURES	16
4.1	OPERATING HINTS	16
4.2	COMPUTER CONTROL OF RT-21	16
4.3	MASTER/SLAVE (M/S) MODE	17
4.4	M/C AND S/C MODES	18
4.5	DEBUG MODE	19
4.6	FIRMWARE UPDATES	19
4.7	CHANGING THE VANITY DISPLAY, MOTION TIMEOUT, SECURITY LOCK	20
4.8	ALTERNATE OFFSETS (FIRMWARE 1.6 AND LATER)	20
4.9	ADVANCED OPTIONS (FIRMWARE 1.6 AND LATER)	20
5.0	ERRORS AND TROUBLESHOOTING	23
	APPENDIX A – OPTIONAL CONFIGURATION	25
	APPENDIX B – ROTATOR IDENTIFICATION	26
	APPENDIX C – RT-21PP SCHEMATICS	27
	APPENDIX D – COMMUNICATIONS PROTOCOL	29
	APPENDIX E – SETUP UTILITY	30

\

1.0 QUICK START GUIDE

IMPORTANT - Please Read This!

This Version of the RT-21 controller is designed specifically for Prop Pitch Rotators using 3 motor wires, CW, CCW and COM(MON). It will operate any DC MOTOR rotator that will run 24-28 VDC with 3 wire, or more modern 2 wire motors. It can support position feedback systems of pulse counts up to 32,600:1 or potentiometers between 250 Ohm, and 10K Ohm, or simple variable resistors to ground of 500 Ohms. For information on optional configurations, see Appendix A.

This Section of the manual will assist you in getting your new controller running as fast as possible. Everything you need to know to get your unit setup and running is contained in this QUICK START. The SETUP UTILITY program on the CD can be used to test your Rotator, operate it, or make settings changes. See the Appendix for SETUP Utility capabilities and instructions.

Your Prop Pitch controller was shipped from the factory all setup for a small Prop Pitch rotator, North Centered and Calibrated to North (0.0 Degrees). If you do not need to change the default settings, you may simply connect up the controller to your rotator, **careful to observe the connections in paragraph 1.5.**

If your antenna is already centered and at North, or you haven't yet installed an antenna, then you do NOT even need to change the calibration and your all ready to go. You may skip the remaining parts of this Quick Start.



Most Prop Pitch rotators do not have mechanical limits, DO NOT attempt rotation other than with the CW and CCW pushbuttons before calibration has been completed, and the soft limits are proven to be working as desired.

The remainder of the manual (After the Quick Start) will assist you in getting the most out of your controller by optimizing the various options, using the computer interface, or setting up sophisticated Master/Slave, or Master/Counter-rotate systems. Feel free to contact us with any questions or clarifications –OR- for any custom application you may have.

TERMINOLOGY

The following terms may be unfamiliar to new users of the RT-21 and are defined here for clarity. It is important to understand their meanings, as they will be used frequently during configuration and setup tasks:

TERM	DEFINITION
Endpoints	The counter-clockwise (CCW) and clockwise (CW) endpoints refer to the ends of rotation that would normally occur with a system that rotates exactly 360 degrees. Note that CCW and CW endpoint headings are the same, but at opposite ends of a 360-degree arc (with the center-of-rotation being 180 degrees from either endpoint).
Over-Travel	Rotation beyond the normal endpoints of 360 degrees.
Point-and-shoot	This action refers to setting a direction with the front panel Heading Knob and allowing the RT-21 to execute this move automatically, stopping at the selected heading.
Soft Limits	These are travel limits that can be programmed into the RT-21. The effect is similar to the mechanical limits built into many Rotators, but it is achieved inside the controller and is fully programmable to allow over-travel (if supported by the Rotator) or to reduce travel for installations requiring limiting the rotation to less than 360 degrees (a sidearm antenna mount, for example). If a Rotator does not have mechanical endpoints, this feature helps avoid turning the Rotator past a desired range.
Ramp-up/Ramp-down	This RT-21 feature provides gradual startup and shutdown of Rotator power to reduce stress on towers, antennas and Rotators. This is achieved by pulse-width-modulating the operating voltage for the Rotator. Ramp-up is utilized for all starts, and ramp-down is used on all stops. (The ramp down is abbreviated for manual button releases, CANCEL or computer 'stop' commands)
Offset	This value sets the desired CCW Endpoint which then indirectly sets the Center of Rotation. A value of 180 is a North Center, a value of 0 is a South Center.

NOTE: The compass headings of 360 and 0 degrees refer to the same direction. There are cases where the SETUP display may read 360 degrees instead of 0, but it refers to the same compass direction of North. During normal operation, the heading display will always display within the range of 0 to 359.9 degrees.

1.1 JUMPERS and SETTINGS

The only PCB board option with your Prop Pitch controller is the optional setting for use of a Potentiometer or 2 wire variable resistance as the position feedback system instead of the normal Pulse Count system. Your controller came from the factory setup for the normal pulse count system. If you are going to use a potentiometer for your directional feedback, please refer to Appendix A.

1.2 VERIFY 115/230 VAC SWITCH

- This switch **MUST** be set to the choice that is correct for the primary (mains) voltage that will power your RT-21pp.
- If the position of the 115/230 VAC switch is moved, check the rear panel fuse for proper value. The fuse is an International Standard GMA 5mm x 20mm type, and should normally be a 3.15 or 4A Slo-Blo fuse for 115 VAC line, or a 2A Slo-Blo fuse for 230 VAC line.

Connect the power cord to the rear panel receptacle and set the front panel power switch to ON. You should first see the start-up message, then the software version number, followed by the operating display.

1.3 SET THE OFFSET VALUE (default is North Center, OFFSET = 180)

The offset value is the number of degrees that your counter-clockwise (CCW) endpoint is from true North. It is normally equal to the compass heading of your CCW endpoint.

For example: If your center-of-rotation were South (with the CCW endpoint at North) then your offset would be 0. If your center-of-rotation were North (with your CCW endpoint at South) then your offset would be 180 degrees (Default).

1.3.1 Configure the desired Offset value

1. Enter SETUP mode
 - Press and hold down the SETUP/ITEM button for 2 seconds
 - Release the SETUP/ITEM button when SETUP appears on the display.
2. Choose the **OFFSET** parameter
 - Repeatedly press and release the SETUP ITEM button until **Offset** is displayed
 - The currently set offset will be displayed after the equals sign (=).
 - The bottom line on the display will indicate **NEW VALUE = XXX**.
3. Set the **OFFSET** parameter for your Rotator
 - Rotate the heading knob until the desired **OFFSET** is displayed after **NEW VALUE =** on the display.

NOTE:	For North Center – OFFSET = 180 degrees (Default) For South Center – OFFSET = 0 degrees
--------------	--

- Press the CHANGE button to store the New OPTION.
- Press the SAVE button to exit the **SETUP** menu.

1.4 SET THE COUNTER DIVIDE RATIO (Default = 9576 - for Small PP Units)

NOTE: Changing the Divide Ratio will also change the heading calculation and therefore, it will change the heading too.

These are the commonly found Divide Ratios. There are exceptions! Your K7NV Prop Pitch Rotator comes with the correct Divide Ratio information for your unit.

PROP PITCH VERSION	Divide Ratio
Small	9576
Medium	7063
Large	7056
X-Large	7497 **

** There are also X-Large units that have a Divide Ratios of 5920

1. Enter SETUP mode
2. Press and hold down the SETUP/ITEM button for 2 seconds
3. Release the SETUP/ITEM button when SETUP appears on the display.
4. Choose the **Divide HI** parameter
5. Repeatedly press and release the SETUP ITEM button until **Divide Hi** is displayed
 - a. The currently set value will be displayed after the equals sign (=).
 - b. The bottom line on the display will indicate **NEW VALUE = XX**.
 - c. Rotate the knob until the NEW VALUE = to the first two digits of the Divide Ratio. For a small prop pitch, this will be set to 95
 - d. Press the CHANGE button to store the new value
6. Choose the **Divide LO** parameter
7. Tap the SETUP ITEM button, **Divide LO** is displayed
 - a. The currently set value will be displayed after the equals sign (=).
 - b. The bottom line on the display will indicate **NEW VALUE = XX**.
 - c. Rotate the knob until the NEW VALUE = to the first last two digits of the Divide Ratio. For a small prop pitch, this will be set to 76
 - d. Press the CHANGE button to store the new value
8. Press SAVE to exit SETUP mode

1.5 CONNECT THE RT-21pp TO YOUR ROTATOR



Remove power from the unit before making connections IT IS EXTREMELY IMPORTANT THAT THE WIRE TO THE MOTOR COMMON IS NEVER CONNECTED TO GROUND, OR ALLOWED TO SHORT TO GROUND.

Function	RT-21pp
MOTOR CW	1 – CW
MOTOR CCW	2 – CCW
MOTOR COMMON	6 - COM
PULSE +	4 - POS
PULSE -	3 - GND

The three wire terminal block on your K7NV prop pitch is marked to identify the CW & CCW terminals, the center terminal is for the COMMON lead.

Your Prop Pitch motor draws a lot of current. You must use heavy gauge wires for your motor to CW, CCW and COM terminals. We suggest something like #10-3 Romex for runs up to a couple hundred feet. You may use #12 for very short runs, and you may want #8 for longer runs. We can also supply Remote Power Units to allow you to place the high current power supply components closer to the rotator and run much smaller wiring into the shack. See the website or call for more details.

The result of running smaller wires, or longer runs are slower rotations. You should be able to obtain 1 ½ minute rotation using the above recommendations. It's OK if it runs slower. Longer runs will reduce full torque however, but these rotators typically have plenty of running torque to spare.

The wires to the pulse switch can be much smaller. #20 or even #22 is fine up to many hundreds of feet.

There is no polarity requirement for the pulse wire connections on the rotator, either wire from the controller may be connected to either terminal on the rotator. It is recommended that all connections to the rotator be sealed with a material such as "Liquid Electrical Tape."

1.6 CALIBRATE YOUR ROTATOR



DO NOT use the Point-and-Shoot knob before your Rotator is calibrated.

Rotators without mechanical limits may be damaged or Rotator loops may be exceeded if unintended over-travel occurs.

Always enlist a spotter or take extra precautions until you have calibrated your unit and verified that the limits are operating correctly!

If you have not yet installed your antenna or were already at North (South if OFFSET = 0), then make sure your display reads 0 degrees (180 if OFFSET = 0). If so, you are done and ready to go.

If you had changed the Divide Ratio, or your antenna is already up, fastened to the mast at something other than your center of rotation, then simply:

- 1.6.1 Enter SETUP (press and hold CANCEL until SETUP appears) and turn the knob to change the CALIBRATION – New Value equal to your antenna’s current direction.
- 1.6.2 Press CHANGE, and then SAVE.

	Make sure that your coax loops are correctly positioned to allow full rotation once your system is up and calibrated.
---	--

1.7 SPEED and RAMP ADJUSTMENTS

Each system is unique due to the length & size of the wires to power the prop pitch motor. The best MIN SPEED to use is the lowest one that will cause the rotator to turn without causing a “POSITION FAIL ERROR.”

This will provide the minimum torque on the antennas & tower, and result in the least amount of overshoot when arriving at the desired target headings

To find the MIN SPEED for your system, try setting the MIN SPEED value to a low number like “1 or 2” and then try to rotate by pressing one of the manual CW or CCW buttons. If the controller display does not show movement on the display and then shows the POSITION FAIL error, then the value is too low. Change to the next higher MIN SPEED value and test for rotation again. When the rotator turns without producing the POSITION FAIL error, you have found the best MIN SPEED for your system.

You may find that a RAMP value, that works fine during warm parts of the year, is too low for cold weather. If you get POSITION FAIL errors in cold weather, increase the MIN SPEED one number at a time until it rotates properly. This may require a RAMP adjustment to longer ramps.

To find the proper RAMP Value, you need to have someone rotate the system 90 deg with the point & shoot knob, while you observe how the antenna and tower react to the movement.

If the tower and antenna(s) windup and move behind the rotator on “ramp up” and then wind up and oscillate at the end of the “ramp down”, your ramp is too short (RAMP value too small). Increase the RAMP value until the antenna(s) start and stop smoothly without tower/antenna oscillation.

The best MAX SPEED is usually 10. This provides the shortest rotation time between headings, and will not cause excess tower/antenna torque and oscillations if the RAMP is correct for the antenna array.

2.0 FRONT PANEL CONTROLS & DISPLAY

2.1 FRONT PANEL CONTROLS

The controls on the front of the RT-21pp include three push buttons, the heading knob and the power switch as shown in Figure 2. Each of the push buttons has two labels, one above and one below. The active function of the buttons depends on whether the unit is in Setup or Normal Operation.



2.1.1 Front Panel Buttons—Normal Operation

When the RT-21 is in normal operation, the push buttons function using the labels *above* the buttons. Table 1 summarizes their functions.

Table 1. Button Functions in Normal Operation

Button Label	Button Function
CCW	Turns Rotator counter-clockwise (## Ramp-down and creep)
CW	Turns Rotator clockwise (## Ramp-down and creep)
CANCEL	In normal operation mode CANCEL can be used in three ways: <ul style="list-style-type: none"> • A tap of the CANCEL button cancels the current rotation event from the front panel heading knob or computer command. • Holding the CANCEL button down for 2 seconds places the unit into SETUP. • A tap of the CANCEL button toggles in or out of M/C, M/S, or S/C mode to allow a manual operation to be performed. • A tap of the CANCEL button will toggle among the three optional OFFSET values when in the optional OFFSET mode. (see Mode=OFFSET)

tapping the CCW or CW button, while computer or point-and-shoot motion is in progress, will ramp down to Minimum speed but continue to target unless CANCEL is pressed.

2.1.2 Heading Knob—Normal Operation

The heading knob on the RT-21 is used to choose a heading for “Preset/Point-and-Shoot” rotation. The scale is appropriate for either a North or South center-of-rotation. When the knob is moved to the desired heading, the RT-21 begins Rotator movement automatically.

NOTE: The scale is a close approximation of the knob position. The exact position is always shown on the front panel digital display.

2.1.3 Front Panel Buttons—Setup Operation

When the RT-21 is in Setup, the three push buttons function using the labels *below* the buttons. Table 2 summarizes their functions.

Table 2. Button Functions in Setup

Button Label	Button Function
SETUP/ITEM	The SETUP/ITEM button has two functions. <ul style="list-style-type: none"> • Initiate Setup Mode: Press and hold down the button for 2 seconds, release when “SETUP” appears in the display window. • Select the next item in the SETUP menu: Repeatedly press the button until the desired setup item appears on the display.
CHANGE	Modify the currently selected item to the value shown in the display window as set by the heading knob.
SAVE	Save changes and exit setup mode

FRONT PANEL CONTROLS AND DISPLAY

2.1.4 Heading Knob—Setup Operation

When in SETUP, the Heading Knob is used to select desired values on the display.

2.1.5 Combined Button Functions

Additional functions are available when certain combinations of buttons are pushed together. Refer to Table 3 for an explanation of these additional functions. When invoking these functions, lead with the CANCEL slightly ahead of the CW, CCW or both.

Table 3. Combined Button Functions

Button Combination	Function
CANCEL+CCW	Calibrate CCW at CCW endpoint. (Pot position only)
CANCEL+CW	Calibrate CW at CW endpoint. (Pot position only)
CANCEL+CCW+CW	Restores all default values to factory settings.

2.2 FRONT PANEL DISPLAY

The front panel display (Figure 3) is a multi-function, backlit LCD.

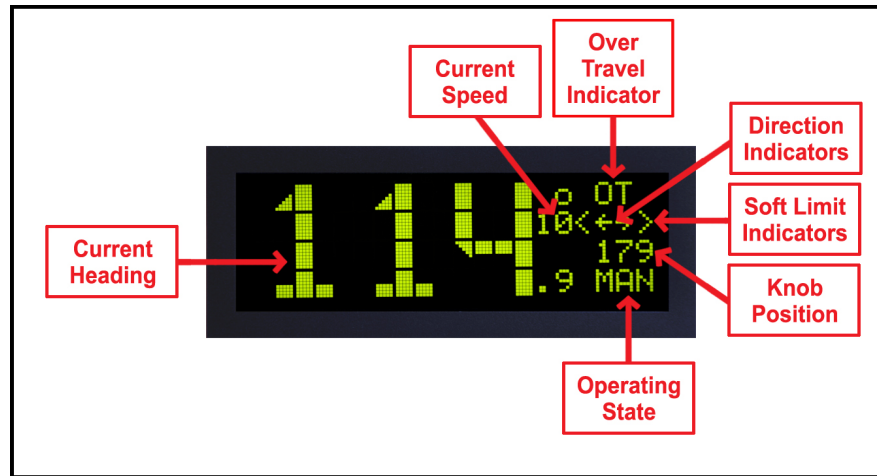

Figure 3. RT-21 Front Panel Display

Table 4. Display Fields and Functions

Field Name	Valid Values	Definition
Current Heading	000.0 – 359.9	Compass heading of antenna in a properly calibrated system. Tenths not displayed for OPTION HAM or T2X
Current Speed	1 – 10	While motor is running, this displays the actual PWM speed to the motor. (1 = 10% .. 10 = 100%)
Over-Travel Indicator	OT	Over-Travel outside of the normal endpoints of 360-degree rotation. (Rotators that allow rotation beyond 360 degrees with wider stops, or no stops at all use this.)
Soft Limit	< >	Rotator has reached the soft limit set in the Rotator SETUP. The RT-21 will not allow rotation beyond these points.
Direction Indicators	→ ←	Direction of current Rotation/Movement. Right indicates clockwise; left indicates counter-clockwise.
Knob Position	0 – 359	Shows exact position of the heading knob. It is used for choosing a precise setting when doing setup commands or in “point-and-shoot” operation.
Operating State	MAN	Manual—Local operation with front panel controls.
	PRE	Preset—Displayed when RT-21 has sensed movement of the heading knob and a point-and-shoot operation is in progress.
	REM	Remote—Unit being controlled via the RS-232 line from another device.
	M/S	Master/Slave Mode—Unit connected to other RT-21 for coordinated operation.
	M/C	Master Counter-Rotate—Connected mode S/C unit can compensate for movement from this unit.
	S/C	Slave Counter-Rotate—Slave unit is compensating for movement from mode M/C unit, such as on a rotating tower, where a specific antenna must maintain its heading.
	OF1, OF2	OFFSET MODE—When an Alternate OFFSET is being use to display heading of antenna.
	DBG	Debug—Used for system troubleshooting. Provides continuous display update, and disables NO MOTION and POT Out-of-Range errors.

3.0 SETUP MODE

The RT-21 Rotator controller allows you to program virtually every aspect of your rotators operation. The controller's **SETUP** menu is used to set all operating parameters.

The first setup task is to select the **OPTION** parameter. This prepares the controller for the requirements of your Rotator system.



The correct **OPTION** for your Rotator must be selected and saved prior to changing any other items in **SETUP**

3.1 OPTION PARAMETER

The **OPTION** parameter setting provides the correct startup conditions for your system and makes items that pertain to your Rotator accessible in the **SETUP** menu.

The RT-21 supports the following **OPTION** values:

POT – 2 or 3-wire potentiometer or variable resistor.

The **POT** option uses the potentiometer method of determining the position of the Rotator. The RT-21 reads the voltage on the wiper of the potentiometer using a precision A/D converter and displays the result in degrees.

COUNTER – Pulse Counter (Default for Prop Pitch)

The **COUNTER** option uses the “pulse counter” method of determining the position of the Rotator. A reed or proximity switch generates pulses, which are read and counted by the RT-21. This count is used to calculate the current position of the Rotator in degrees.

To setup the **OPTION parameter, perform the following steps:**

1. Enter **SETUP** mode
 - Press and hold down the **SETUP/ITEM** button for 2 seconds
 - Release the **SETUP/ITEM** button when **SETUP** appears on the display.
2. Choose the **OPTION** parameter
 - Repeatedly press and release the **SETUP ITEM** button until **SETUP-OPTION =** is displayed

SETUP MODE

- The currently set option will be displayed after the equals sign (=).
 - The bottom line on the display will indicate **NEW VALUE = XXX**.
3. Set the **OPTION** parameter for your Rotator
- Rotate the heading knob until the desired **OPTION** is displayed after **NEW VALUE =** on the display.
 - Press the CHANGE button to store the New **OPTION**.
 - Press the SAVE button to save the option and exit the **SETUP** menu.

3.2 SETTING OTHER PARAMETERS

This same sequence that was used to set up the **OPTION** parameter is used to modify any setup parameter (SELECT, CHANGE, SAVE).



It is important to remember that if you change an **OPTION** parameter, you must SAVE and reenter the **SETUP** menu to make any other changes

TIP: Some menu items can change calculations and affect related options, so it's a good idea to only change one item at a time until you become familiar with the RT-21. For example, changing the **CTR** divide ratios will change the **CALIBRATE**, the **OFFSET** will change the **SOFT LIMITS** to match, etc.

3.2.1 SETUP ITEMS

This section provides a detailed description of the options available in the **SETUP** menu. The parentheses () indicate the option setting(s) under which the item is available.

CALIBRATE – This item calibrates the directional display to the physical direction of your antenna.

OFFSET – Sets the CCW endpoint for your system in degrees clockwise from true North. The default setting is “180”. This means that the default stops are at South with a North center-of-travel. To set a South center, you would set the **OFFSET** to “0”. This setting also affects the soft limits within the RT-21 and repositions them automatically if you change the **OFFSET** value.

- You may have both “South center” and “North center” antennas on the same mast and Rotator. For example, you may wish to put a VHF antenna on South center and HF antenna on North center. You can select which center-of-rotation is to be used by simply changing the **OFFSET**.
- The **OFFSET** is also useful in a POT system to compensate for mast slippage as a temporary measure until you can re-align correctly.
- Mobile “rover” stations can use the **OFFSET** feature as well. Simply enter the amount of offset depending on how far off your vehicle is parked from a North heading.

DELAYS – This sets the delay times enforced by the RT-21 before allowing a reversal in motor direction, or before the Brake engaged. This delay setting is adjustable in 1 second increments up to a maximum of 6 seconds.

SETUP MODE

MIN SPEED – This sets the minimum speed that that is used for starting and stopping the motor as it ramps up and/or down, 1 to 10 where 1 is 10%... 10 is 100%.. The MIN SPEED setting has no effect when ramps are not used (Min and Max Speed = 10). Generally, this is set to the slowest speed that allows your Rotator to turn reliably, typically 3 or 4 for Prop Pitch motors

MAX SPEED – This selects the motor speed, 1 to 11 where 1 is 10%...10 is 100%. For speeds within 1 to 10, ramp-up and ramp-down power is applied to the Rotator. This reduces tower stress on large arrays. Speed 11 forces MIN SPEED and MAX SPEED both to 10 for full speed with no ramp-up or ramp-down conditioning.

CCW LIMIT – Selects the absolute heading for the CCW soft limit. The soft limit may be set +/- 180 degrees from the normal CCW endpoint. (Normal endpoints apply to systems that allow 360 degrees of rotation with mechanical stops.)

CW LIMIT – Selects the absolute heading for the CW soft limit. The soft limit may be set +/- 180 degrees from the normal CW endpoint. (Normal endpoints apply to systems that allow 360 degrees of rotation with mechanical stops.)

OPTION – Selects the Rotator type. Described earlier in this section.

DIVIDE HI – Selects the first two digits (high order) of the pulse divider. The divider number is equal to the number of pulses in a 360-degree rotation. For example, if your Rotator provides 9576 pulses in 360 degrees, the **DIVIDED HI** value is set to 95.

DIVIDE LO – Selects the last two digits (low order) of the pulse divider. The divider number is equal to the number of pulses in a 360-degree rotation. For example, if your Rotator provides 9576 pulses in 360 degrees, the **DIVIDE LO** value is set to 76. (Always set the **DIVIDE HI** first, then the **DIVIDE LO**.)

NOTE: The divide ratio may be set as high as 32,600 in order to support high accuracy, high ratio custom systems. If the ratio must be set higher than 9999 (HI > 99) then the SETUP UTILITY must be used to set the Divide Ratio value instead of the front panel SETUP Mode

CAL RANGE (Available only with OPTION = POT) – This is the degree range that the potentiometer calibrate routines will assume for the distance traveled between the CCW and CW calibration points. This value defaults to 360 degrees and should not be changed unless you cannot rotate your antenna full 360 degrees in order to perform the potentiometer calibration. (A sidearm application on a tower may be one example of this.) You can calibrate the Rotator prior to physical installation, or use the **CAL RANGE** to set this parameter. Refer to Section 5—Advanced Features—for a detailed sidearm calibration procedure.

MODE – Selects the operating mode of the RT-21 controller.

SETUP MODE

- **NORMAL** Mode – NORMAL mode allows manual control, point-and-shoot and computer control via one of the rear panel communication ports.
- **M/S** – Master/Slave Mode, where multiple RT-21 controllers are linked together.
 - Usage and Examples:
Master/Slave mode allows one RT-21 to control other RT-21 controllers via the EIA-232 port. This allows movement of multiple Rotators and antennas to the same heading without having to set each one individually.
The **M/S** MODE is intended for use in controlling stacks of HF monobanders or tribanders that are on different Rotators (or even different Rotator types). It allows the operator to turn the entire stack together or quickly separate them for individual rotation.
When you set the **MODE** to **M/S**, you may quickly disable or enable the M/S mode by pressing the CANCEL button.
 - Functionality
If you only have a stack of two antennas, each with its own Rotator, either controller may be used to turn the pair.
If you have three or more antennas on different Rotators, then one of the controllers must be designated as the Master. The controller designated as the Master is the only one that will turn all of the antennas. The other controllers will only turn the antennas they are directly connected to.
Refer to Section 5—Advanced Features—for more detail on M/S operation and EIA-232 connections.
- **M/C** – “Master/Counter-Rotate” Mode
 - Usage and Examples
Master/Counter-Rotate Mode is used for the bottom Rotator (or tower) in a system where two Rotators are used in series along the same “mast”. Examples of this are a Rotator at the top of a rotating tower, or two rotating joints on the same structure (or rotating rings mounted on a rotating tower).
 - Functionality
M/C mode sends the heading data to other RT-21s that control the upper Rotator(s) so that it may calculate the heading for the antennas above.
- **S/C** – “Slave/Counter-Rotate” Mode
 - Usage and Examples
S/C mode is used for the slave Rotator(s) as described in M/C. It reads the data from the M/C unit and maintains the heading for the upper antennas while the bottom is moving. The S/C controller in a properly implemented system allows complete independent operation of the slave antennas from the ones fixed to the rotating tower.
- **OFFSET** – Alternate OFFSET Mode. (See Section 4.9 for details)
- **DEBUG** – Debug Mode (see section 4.6 for details)

SETUP MODE

RAMP – Adjusts the variable ramping, (0-9) of the speed control features of the controller. 0 = shortest, 9 = longest ramp. Generally, the larger your system, the longer ramp up and down you will want to use. Default is 3.

BRIGHT – Adjusts the variable brightness of the LCD display 1 to 10. **(1 to 4 for the VFD used in the 'D' models)**. The display automatically dims after a short time of no display updates.

4.0 OPERATING HINTS & ADVANCED FEATURES

4.1 OPERATING HINTS

A review of the Operating Hints below will help you get the most out of your RT-21pp and resolve minor difficulties that may be encountered. In addition, Green Heron Engineering is available to assist with any questions you may have about your controller. Use the contact information at the front of this manual to reach us.

1. RAMP and MIN SPEED SETTINGS should be tailored to your specific rotator and load. If your rotator tends to overshoot a few degrees, reduce the MIN SPEED or increase the RAMP. If your rotator gets ERROR NO MOTION on start-up, or at the end of a rotation prior to reaching the target, then set the MIN SPEED higher.
2. Prop Pitch Rotators without mechanical limits must depend entirely on the controller to prevent rotation beyond the desired range and to prevent damage to your coax and/or potentiometer. The RT-21 incorporates extra protection for these Rotators by shutting down the motor Power Supply when the motor should not be turning, watching for pulse count failures, and monitoring the pulse counter for OUT-OF RANGE conditions. MODE = DEBUG when turned on, will allow the controller to ignore these errors and continue to operate. Please be very careful when using MODE = DEBUG as most of the over-rotation safety features are disabled.
3. The RT-21 is protected by a fuse on the rear panel. If the controller shows no sign of power, the fuse may be blown. The fuse is an International Standard GMA 5mm x 20mm type, and should be replaced with a 3.15 Slo-Blo fuse for 115 VAC operation, or a 2A Slo-Blo fuse for 230 VAC operation. Replacement fuses are available at most electronics parts distributors, including Radio Shack.
4. The RT-21pp is designed such that relays are NEVER hot switched. In the event of a drive FET failure or a short to ground on one of the motor leads, the controller may not be able to control the speed and ramping correctly and hot switching of the Fail Safe relay may occur. This will result in your rotator not ramping up and down, and it will overshoot the target heading by more than 10 degrees. CONTINUING TO OPERATE YOUR CONTROLLER IN THIS CONDITION MAY RESULT IN RELAY FAILURE AND EVENTUAL CONTINUAL ROTATION AND COAX DAMAGE!!!!

4.2 COMPUTER CONTROL OF RT-21

The RT-21 is equipped with a fully operational RS-232 port and a USB 'B' connection. Virtually all programs that support Rotator control via a COM port can be used with the RT-21 on either port. The RT-21 USB port implements the standard COM port emulation that works with standard Windows drivers. See 5.2.2 for installation instructions.

The protocol implemented in the RT-21 is based on the Hy-Gain[®] DCU-1 protocol and runs at **4800 8N1** using a **straight through serial cable** with at least pins 2-2, 3-3 and 5-5 wired. It reports headings and turns to headings with the same commands implemented in DCU-1. Set your software to use DCU-1 protocol at 4800 8N1 if your program does not have a Green Heron setting. Many additional commands are provided for the advanced features that only your RT-21 can perform. These include the ability to computer track to 1/10th degree using GH Tracker, or operate your controller as part of an IP network using GH Everywhere software from Green Heron.

4.2.1 USB Functionality is limited to computer control. You cannot use the USB to interconnect RT-21s for the purpose of Master/Slave, or Counter-rotate functions.

NOTE: The EIA-232 Port (dB-9) **MUST** be used for interconnection to other RT-20, or RT-21 controllers **AND** for loading new software updates from Green Heron. (RT-21 v3 allows USB software updates, see page iii)

4.2.2 USB INSTALLATION

The RT-21 requires a driver settings file (INF) file to be installed on your system. When your system first sees an RT-21 connected to a USB port on your computer, the New Hardware Wizard will appear. Although the exact procedure will vary depending on your operating system, Windows will ask you for the location of the Driver for an RT-21 controller. You browse to the CD provide to the drivers folder and select the driver file RT21usb0.inf, and then install the driver. You may ignore the "digital signature" error if you get one.

4.3 MASTER/SLAVE (M/S) MODE

M/S mode allows multiple antennas to be rotated as if they were on the same mast, even if in fact they are on separate towers, masts or Rotator types. Primarily intended for stacked arrays of similar antennas, this mode could be useful in other ways. One might be the VHF operator with antennas for different bands on different Rotators or towers. You could turn the SHF array to a desired heading as you work a distant station on the lower bands on a different tower.

A controller in the M/S mode sends commands to other controllers using the EIA-232 port. Controllers in **NRM** mode or **M/S** mode will "read" these commands and turn their motors to match. If you wish to momentarily disable the commands from being sent from the Master unit, simply press the CANCEL button and the **MODE** will change to **MAN** on the display. Pressing CANCEL again will return to **M/S** mode.

An M/S unit will send commands for point-and-shoot and computer-generated events, but not for manual button presses. If you have only two controllers, both units may be set to **M/S** and then either one will turn the stack, unless momentarily disabled with CANCEL. With three or more Rotators in the stack, only one unit may be designated as **M/S**. In addition, computer control may still be used on the stack. The computer must be connected to the unit that will be the **M/S** mode unit, if a computer is used with a

two-unit setup, then only one RT-21 (the one connected to the computer) can be the Master unit. A computer port may be directly connected to any or all unit in a stack if the USB port is used. In this case, only the Master unit's connected port will send the stack to a heading, while Slave unit's connected port will only act on that Slave.

4.3.1 INTERCONNECTIONS:

1. For two controllers without a computer interface
 - Connect the two units together with a DB-9 null modem cable.
 - The only pins needed are 2-3, 3-2, and 5-5.
2. For connection with a computer and two or more RT-21 units, proceed as follows: (IF USB port is used with the Master, than the Computer part of the cable on the right side of the drawing isn't used.)
 - Cable the units as shown in Figure 4.
 - Note that only two wires are needed on units set to **MODE NORMAL**.
 - Pre-made cables are available from Green Heron Engineering. Check our website for details.

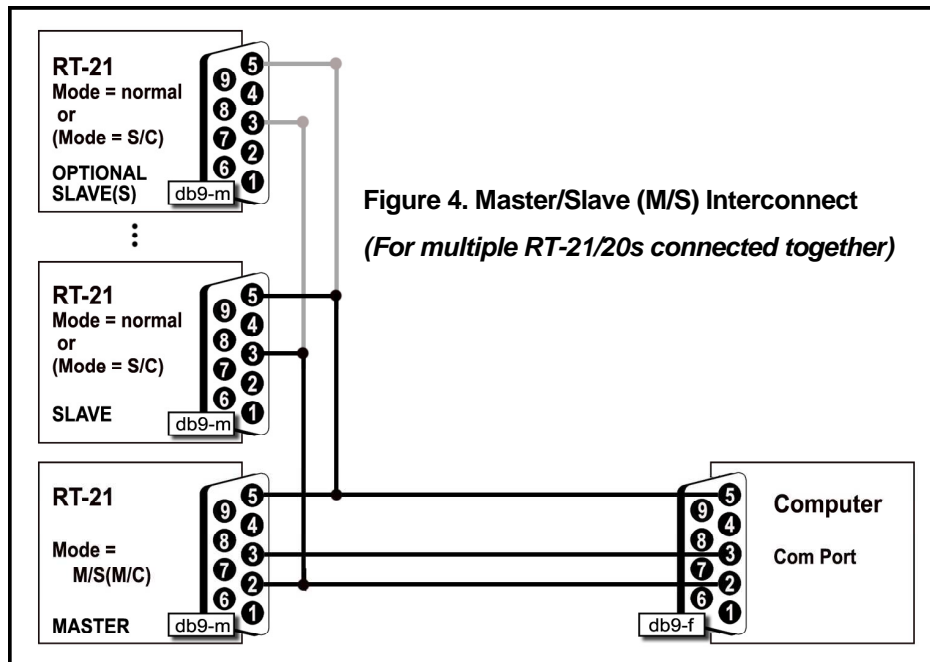

4.4 M/C and S/C MODES

These modes are used to configure a counter-rotating scheme where one Rotator is mounted above another as you might wish to do with a rotating tower. In this case, the tower turns the antennas that are fixed to it, and a separate Rotator turns a mast above the tower. This could allow separate or slaved operation of stacked antennas, or separate control of two independent antenna systems.

In this configuration, the lower Rotator controller is set to **MODE M/C** while the upper controller is set to **S/C** (Master and Slave Counter-Rotation). The cabling is the same as you would use for the M/S two-Rotator scheme, with or without a computer. The computer can only control the lower Rotator in this configuration. The **S/C** unit always seeks the heading set with the point-and-shoot knob on the front panel.

All **S/C** units attempt to hold headings as set with the **Heading Knob**. Although units will respond to the **CW** and **CCW** buttons, the next rotation of the master unit will cause a return to the knob position.

The lower unit will turn as commanded, either manually, point-and-shoot, or by software command, and the upper unit will compensate and hold the desired, indicated heading by turning in the opposite direction. When beyond an endpoint (soft limits), the upper unit “flops over” and turns 360 degrees in the other direction.

It is important to calibrate the slave units *after* the master one. Set the master one to the center-of-rotation (normally North or South) and then calibrate the slaves to the same heading.

There is an internal setting that allows you to customize the time delay between Counter-Rotation commands sent from the Master. This will act to slow down or speed up the reaction of the slave to the master and reduce or increase the number of slave turn commands that occur for any motion from the Master. The default value for this is 10 seconds, contact the factory if you need to adjust this value.

Use **M/C** for your main rotating tower base or rotating joint. Use **S/C** for the upper Rotator (above the tower) and/or Ring Rotator® or sidearm installations *above* the rotating joint. The master unit may be turned by any allowable method (manual, preset, computer). The slave units will track their current heading as set with the heading knob. **S/C** headings may be changed using the heading knob only. A slave unit counter-rotates beyond the soft limit, the unit “flops over” and turns 360 degrees in the other direction.

4.5 DEBUG Mode

4.5.1 This mode enables troubleshooting of the system by allowing continuous rotation regardless of detected errors:

1. It enables continuous updating of position data on the display.
2. It disables the **NO MOTION and COUNTER RANGE ERRORS** from resetting the controller so that you may determine the cause of these errors. **Naturally, with MODE = DEBUG, caution to prevent over-rotation should be exercised if your system has no mechanical limit switches.**

NOTE: The standard K7NV prop pitch rotators do not come equipped with mechanical limit devices.

4.6 FIRMWARE UPDATES

Firmware updates, should one ever be desired or needed, are easy and fast to field install. The process requires only a straight through serial cable (the same one you may be using for computer control), the loader program that was provided with your RT-21 on the CD (tinybldWin.exe), and the program file (.hex) that you wish to load. The firmware that came installed in your unit is also on the CD in case you need it for any reason. Updates cannot be done using the USB port on the RT-21.

To use the loader:

1. Place the tinybldWIN.exe and the firmware file (.hex) in a folder and go to that folder.

2. Double click the program and “Browse” and select the hex file you want to load. Set the Comm window to 57600 and the COM port you are going to use.
3. With the RT-21 switched ON, connect the serial cable. Click on Write Flash and then quickly turn the controller OFF and then back ON before the loader times out.

NOTE: The latest RT-21pp units may download easier if you first turn the controller off, then click on Write Flash, then turn the controller ON before the loader times out..

The loading process should take just a few seconds. Stored SETUP values are not changed so your calibration should remain intact. If the new load adds new SETUP values or features, you may need to go and set these new values before using your RT-21 with the new software. Green Heron will provide these instructions if needed.

4.7 CHANGING THE VANITY DISPLAY, MOTION TIMEOUT, SECURITY LOCK

There are some SETUP items that are not accessible from the front panel SETUP menus. These items are designed to add security or items that should not normally need to be accessed except on rare occasion. To access or change these items, use SETUP UTILITY (Appendix G).

4.8 ALTERNATE OFFSETS (Firmware 1.6 and later)

Allows user to set two alternate beam OFFSET values and to then quickly and easily toggle heading displays to them sequentially by tapping the CANCEL button. This is useful for stacking antennas on the same mast that have different orientations, or pattern directions. Eliminates the need to mentally add or subtract headings for different antennas that are mounted 90 or 180 degrees off of the main antenna, or for use with a rotary dipole or other antenna that is bi-directional. You use SETUP UTILITY to set one or two alternate OFFSET values and MODE=OFFSET in order to enable the feature. The status display indicates MAN, OF1 or OF2 to show selected OFFSET.

4.9 ADVANCED OPTIONS (Firmware 1.6 and later)

These Advanced Options are only accessible via the SETUP Utility software’s Advanced Options Tab.

- 4.9.1 Un-Freeze Display – This option allows the display to always track the Heading feedback at a slow rate as opposed to freezing the display to prevent digit rolling.
- 4.9.2 Fast Brake Release – This option ignores the DELAY setting for the Brake Release feature to allow the use of the Brake Relay for Contact Closure applications. This function is N/A to RT-21pp
- 4.9.3 Auto Go-Back – Allows automatic compensating for long ramp downs when using manual CW and CCW Buttons. After releasing a button, if you tap it again while the Rotator is ramping down, the unit will reverse

OPERATING HINTS & ADVANCED FEATURES

after the stop, and go back to the heading at the time of the initial button release. An extra arrow indicator will show you that it will reverse after the delay.

- 4.9.4 Elevation Mode – This option will change the display to show negative numbers for below the horizon when controlling an elevation rotator. Headings between 261.1 and 359.9 will display as –99.9 through –00.1.
- 4.9.5 Analog Out – The controller will provide a 0 ~4 VDC output on an unused rear terminal when equipped with the VBI-360 Upgrade Kit. Future versions of the RT-21pp will include this function on the DB-9 RS232 connector. The voltage will track the HEADING value in a linear fashion, intended to drive the **VBI-360 LED** display. Switched +12V to turn on the display may be found on terminal 5 of the rear panel.
- 4.9.6 EME Mode – This option disables the pulse counter after the motor has stopped after the DELAYS time. Intended to eliminate extra counts on very large EME arrays that are caused by the sensor rocking back and forth in the wind. This is only possible for large arrays that move very slowly so that the sensor always stops near the switch, and the array is large enough that the wind can move back through the gears and wiggle the motor shaft.
- 4.9.7 Point & Shoot Shortest Route – This option extends the Shortest Route logic to the Point-and-Shoot knob. Shortest Route turns the rotator the shortest way to get to a heading for rotators that allow rotation more than 360 degrees. This will not work properly if your Soft Limits are not set correctly. Shortest Route is always enabled for computer generated commands.
- 4.9.8 Port 9600 – Sets the baud rate on the EIA-232 DB-9 port to 9600 baud. 4800 Baud is the DCU-1 standard but some programs allow this to be run faster.

OPERATING HINTS & ADVANCED FEATURES

5.0 ERRORS and TROUBLESHOOTING

5.1 Rotator does not run in one direction, runs other direction, no error is displayed.

This is usually the result of an accidental run or calibration set beyond a soft limit. The “bad” direction will NOT show the direction arrow when you try to turn it. You will probably see that the “<” or “>” indicator is on signifying that a soft limit has been reached.

Check the actual position of the antenna and that you haven’t over-rotated it. Re-calibrate and/or correct incorrect Soft Limit settings. It may be appropriate to RESET the controller and then do the calibration. Make sure your rotor loop is in the right rotation.

5.2 ERROR NO MOTION

No Motion errors occur if your Rotator attempts a rotation but does not detect a heading change of at least 2 degree in the allotted time, typically 4-6 seconds. This could indicate either that the Rotator is not turning, OR, it is turning but the feedback mechanism is not working. In either event, the RT-21pp stops the attempted motion to allow you to diagnose the problem without possibly damaging your coax or antennas. The Motor Timeout value may be increased or decreased using SETUP Utility.

TROUBLESHOOTING

First, determine if the motor is turning or not. Have a helper watch the antenna while you press and hold CW or CCW. The controller will try to turn until the error occurs, but this is enough to see if the motor is running.

If the rotator is NOT turning:

1. Disconnect wires from terminals 1 and 2, you should be able to read the rotator motor resistance (a few ohms) between 1 and COM, and also 2 and COM. IF you cannot read the motor windings, then a wiring or motor problem exists.
2. With the wires still disconnected so that the rotator cannot turn, check the RT-21 by setting, SPEED = 10 and, MODE = DEBUG. Push the CW or CCW buttons and read the motor voltage across the terminals 1 and 6 for CW. 2 and 6 for CCW. You should see about 33 VDC no load. With the motor connected, you should read between 20 and 28 VDC while attempting to turn. **BE VERY CAREFUL WHEN MODE=DEBUG. Many of the safety features are disabled and your motor could turn beyond the coax loop. Always use a spotter or other way of watching what is happening.**
3. If the voltage is near zero, this would indicate a problem with the controller. If the voltage is normal, but with the rotator connected, the voltage is very low (like 10 VDC or less), then this indicates that there maybe a mechanical condition that is holding the mast and rotator. With the wires still disconnected so that the rotator cannot turn, check the RT-21 by setting, SPEED = 10 and, MODE = DEBUG. Push the CW or CCW buttons and read the motor voltage

ERRORS AND TROUBLESHOOTING

If the rotator is turning, but the display is not registering any change:

1. Disconnect the wire from terminal 4 of the rear panel. Set MODE = DEBUG. Now, take a clip lead or small short wire and tap terminal 4 to ground repeatedly. If the display counts up or down, then the controller is OK and the problem must be in the wiring or the reed switch in the rotator. The switch usually fails in a shorted position. Measure the wires that go to the switch and see if there is a low resistance condition.

BE VERY CAREFUL WHEN MODE=DEBUG. Many of the safety features are disabled and your motor could turn beyond the coax loop. Always use a spotter or other way of watching what is happening.

2. If the display does not change, then the problem is in the controller. Make sure that the OPTION is set to COUNTER. You may try a full RESET EE of the controller and then try again. There is a transient protection device (Transorb) that typically will protect the controller from a large EMT event, but may short itself in the process. This is usually indicated by a low resistance to ground measured on terminal 4. Or, turn the controller on and measure that the voltage on terminal 4 is at least 10 VDC. If you suspect the Transorb, simply clip it off from terminal 4, and see if the counter now works when taping the clip lead.

COUNTER RANGE ERROR xxxx (New in 1.07)

This error indicates that the value contained in the internal pulse counter is beyond the range allowed for your rotator as determined by the Pulse Divider setting. The controller allows +/- 90 degrees over-travel from 360 as default. The controller will remain inoperative until corrected by either a re-calibration, EE Reset, or turning it back into range by using MODE=DEBUG to ignore the error.

BE VERY CAREFUL WHEN MODE=DEBUG. Many of the safety features are disabled and your motor could turn beyond the coax loop. Always use a spotter or other way of watching what is happening.

Contact the factory if you desire to change the 90 degree OT Limit.

APPENDIX A – OPTIONAL CONFIGURATION

POSITION FEEDBACK USING POTENTIOMETER

This controller may be optionally configured to provide heading position via the use of a potentiometer. The potentiometer must be geared such that that a maximum 90% of the pot is actually used. This will allow the RT-21pp POT Out-Of-Range protection to work as intended to prevent over-rotation. Please contact us if you need to use other schemes.

POSITION FEEDBACK JUMPERS

Position Indicator Type

Source	J5	J6
Counter (pulse)	2-3	2-3
Potentiometer	1-2	1-2
Variable Resistor	1-2	2-3

These jumpers are located on the main PCB near the rear of the controller. Remove the cover for access.

SETUP -> OPTION = POT

Using SETUP mode, set the OPTION parameter to POT

POT CONNECTION

The potentiometer connections must be made as follows:

Potentiometer	RT-21 Terminal
CCW side (High)	5 – REF2-3
Wiper	4 – POS
CW side (Low)	3 - GND

(For 2 wire POT (Variable Resistor) use terminals 3 and 4 only)

CALIBRATION

Your rotator now must be synchronized to the pot position. The calibration is performed by turning the rotator to each end of the 360 degree rotation and performing either the CAL CCW, or CAL CW depending on which side to which you have turned. See par 2.1.5 for how to perform these functions. You may also use SETUP Utility to trigger these calibrations with button clicks. If your pot is geared so, you may still allow over-travel up to the 90% limit of the pot.

NOTE: The Cal points are at SOUTH if using a North Centered (OFFSET = 180) system

CONFIGURE FOR 2 WIRE DC MOTOR

For 2 wire conventional DC motor applications. remove the cover and remove the white wire from J8-4 on the main PCB. Tie it up so it can't come in contact with any other circuit. Add a short jumper from J8-3 to J8-4 on the board. Connect the motor only to terminals 1 and 2 on the rear panel. The voltage is reversed in the controller to reverse directions. If your motor runs backwards from what you intend, simply swap the two wires from the motor.

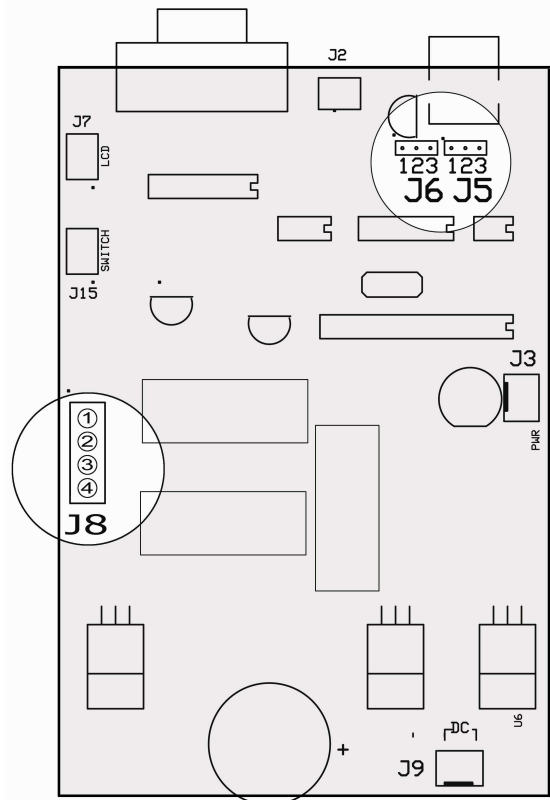

APPENDIX B – ROTATOR IDENTIFICATION

The following pictures are meant as aides in rotator identification. There may be slight differences among certain sizes. This is a guide only!

Left to Right – Large, Medium, Small



Typical of X-Large Rotator

APPENDIX D – COMMUNICATIONS PROTOCOL

The protocol implemented in the RT-21 is a "superset" of DCU-1 and therefore retains its compatibility with most software packages without change. If your software package does not have a Green Heron selection, then try selecting DCU-1 or Rotator EZ.

All RS-232 communications is at 4800 8N1, the DCU-1 standard. The same commands are supported over the USB port. (9600 8N1 may be selected using the Advanced tab in SETUP Utility)

The shaded commands are DCU-1 compatible commands. All commands begin with letter (except the first one in the list) and all commands end with a semi-colon (;). Letters may be upper or lower case. You may type commands at any pace using HyperTerminal, ProComm, or any terminal emulator. There is no inter-character timeout, the buffers may be cleared by simply sending a semi-colon (;).

;	Stops current rotation immediately (short ramp down)
Aln;	Reads Heading 3 digits, leading zeros included in response which is xxx;
AWnxxx(.y);	Writes new Heading xxx.y for Calibrating a Pulse Count System
BlN;	Reads Heading with tenths. Response is xxx.y;
STn;	Stops current rotation immediately (short ramp down)
AVn;	Sends and receives special headings on 232 port only for counter-rotation function.
APnxxx(.y);	Sets rotation degrees to xxx optionally .y (tenths) for the next AMn; command
APnxxx(.y)<cr>;	Sends Rotator to heading immediately, no AMn; required
AMn;	Move Rotator to last AP send heading
R0n;	Read Rotators pot A/D value, response is <SOH>xxxx; xxxx is 0 to 1023 10 bit A/D value
R1n;	Read RT-21 model and version #. response is <SOH> "RT-21 Version X.Y";
RXn;	Read EE value A through Z (See list below)
W00;	Loads Default EE values and Reset Controller
W0n(callsign);	Write vanity message centered on line three of display for boot message
WXn(value);	Write value to EE location A through Z (See list) (SEE n= below for info on EE Write)
C0n;	Force unit to CAL CCW at current position
C1n;	Force unit to CAL CW ant current position
AAn;	Run Rotator CCW for 1.5 Seconds, re-triggerable. (New in version 1.06)
ABn;	Run Rotator CW for 1.5 Seconds, re-triggerable. (New in version 1.06)

n = digit 0-9, n = 0 on WX (WriteEE) commands forces reboot, n <> 0 just writes value.

Commands that return values (other than Al1;) include SOH ahead of data.

EE Locations value of X =:

A – CCW Cal (0)	I – CW Limit (180)	P – Rotator Fail Timeout (4)
B – CW Cal (950)	J – Option(Pot) No default with EEReset	Q – Security (Admin)
C – Reserved	K – Pulse Divider (3960, 4015 in 1.07)	R – Alt Offset 1 (361)
D – Cal Offset (180)	L – Cal Range (360)	S – Alt Offset 2 (361)
E – Delays (3)	M - Mode (Normal)	T – Advanced Options (0)
F – Min Speed (3)	M - Mode (Normal)	U – OT Allow in Degrees (90)
G – Max Speed (10)	N - Ramp (3)	V – Counter-Rotate Delay (10)
H – CCW Limit (180)	O – Brightness (8)	

Advanced Option values for EE Location 'T' (See Advanced Options)

BIT	VALUE	OPTION	BIT	VALUE	OPTION
0	1	UnFreeze Display	5	32	Analog Out (VBI360)
1	2	Immediate Brake Release	6	64	EME Mode
2	4	Auto Go-Back	7	128	Shortest Route
3	8	Elevation Mode	8	256	Port 9600 Baud
4	16	AutoDim in Unfreeze			

APPENDIX E – SETUP UTILITY

Introduction

NOTE: SETUP Utility is also used with other Green Heron controllers. Some options will appear on-screen that will not make sense for a Prop Pitch controller. DO NOT attempt to use any of the Auto-Cal features on-screen. ALSO, do NOT attempt to change the OPTION to anything other than COUNTER or POT even though SETUP UTILITY shows additional choices

SETUP is an easy to use utility that can be used with the Green Heron RT-21 controller to allow computer access to all of the SETUP items that can be done from the front panel SETUP menus. In addition, the SETUP UTILITY additionally provides for:

- Connecting to a controller via RS-232 or USB.
- Rotator control and display of current heading.
- Computer access to the front panel SETUP parameters.
- Access to parameters that are hidden from the front panel.
 - MOTOR TIMEOUT in seconds.
 - Security Setting to allow User lockout of SETUP and Resets.
 - Vanity Display changes for the LCD/VFD at start-up.
 - Direct setting of POT Calibration values
- Ability to Save and Recall calibration parameters for your specific Rotator installations

Connecting

Select a COM port. Only ports that are really available are shown in the drop down Port box. Click To Connect – If a controller is on that COM port, Connected will be displayed in the Port section, and all of the various parameters will be read along with the Current Heading.

Rotator Control

The lower right corner of the window shows the Current Heading (yellow on black window) with a text box available to select a new heading. You can double click the New Heading box to type in a heading. Then click on Go. Stop will send the stop command to the Rotator.

Computer Access to SETUP parameters

Rotator Type is the OPTION setting in front panel SETUP. Mode, Pulse Divisor, Motor Settings, Offset, Cal Range, Soft Limits and the Display Brightness all mimic the Front Panel SETUP parameters. If you have selected a Counter type of Rotator, the Pulse Cal will be available too. See the manual for detailed descriptions of these settings. Some settings are with radio buttons. Some with sliders, and others require you to click on a **Change** button and type in a value.

Limits

The color bar in the Limits window gives you nice visual representation of the soft limits as read from the controller, or changed in the SETUP UTILITY. This bar takes into account both the OFFSET value and the Soft Limit values to graphically represent the rotational range. The center of the Limits window IS ALWAYS the center of rotation. This may not always be coincident with the center of the red bar if the limits are not equally set away from their centers.

APPENDIX E

Do CCW Cal & Do CW Cal

These buttons mimic the front panel CANCEL + CCW and CANCEL + CW buttons that set the actual pot calibration A/D values into the controller. You must first have turned the Rotator to the visual CCW and CW 360 degree endpoints by using the front panel buttons. Please refer to the manual for information on calibrating a POT system.

Use the **Read Settings** and **Write Settings** buttons near the bottom of the Utility window, to read and write from and to the controller.

Reset button will mimic the CANCEL+CCW+CW buttons that cause a complete RESET EE function back to factory defaults.

Computer Access to “Hidden” parameters

Security

If set to User, will disable access to SETUP, RESET EE and Pot Calibration from the front panel.

Motor Timeout

Set this value higher than 5 seconds if your Rotator is slow or you use very long ramping and may exceed the 5 seconds from time to time.

Set Vanity

Will change the boot-up message on the display. You can enter up to 14 characters and they will be centered on the 3rd line of the display at start up. You must restart the controller after using this button. Close the SETUP UTILITY first if connected via USB.

Pot Cal

You may also directly set the A/D values in the CW and CCW calibration locations without actually doing the pot calibration. If you know what the values are for your installation, you can put them back using this facility. You can also make small changes to the stored values, or set them full wide (0 and 960) prior to recalibrating. (as a substitute for doing a full Reset EE prior to calibration.)

The A/D values (Analog to Digital Converter) is the voltage returned from the wiper of the indicator pot inside the Rotator. It can range in value from 0 to around 960 which correspond to 0 VDC, to around 9.8 VDC.

Advanced Options Tab (Upper Left)

Access to the Advanced Options is only allowed on controllers that read Firmware version 1.6 or later. These options are described in detail in Section 5.10 and are only turned on/off with the Advanced Options tab of SETUP UTILITY.

Auto Calibration – DO NOT USE FOR PROP PITCH CONTROLLERS

Auto Cal Orion – DO NOT USE FOR PROP PITCH CONTROLLERS

Save and Recall Settings

You may save and recall complete sets of parameters that are stored in your controllers. This may be useful if you have multiple Rotators and controllers and want backup settings in case you need to replace a controller, or accidentally erase settings. You may also use this facility to re-use one controller on different Rotators in your stations(s) and quickly setup from one to another without having to reset a bunch of parameters and without having to perform the normal calibrations.

After connecting to a controller that you wish to save, verify the settings and then press **Save to File**. In order to recall, do a **Read from File**. The currently connected controller will be restored automatically.

GREEN HERON ENGINEERING LLC

© 2011 Green Heron Engineering LLC

1107 Salt Road, Webster, NY 14580
Phone 585.217.9093
www.GreenHeronEngineering.com
